

# New Generation M4/M4U **MOBILITY ROBOT**



## **Safety**

Super Powerful, Constant Speed Precision Control,  
No Skidding, No Hill Rushing



## **Comfort**

Automatic Adjustment Of Riding Posture,  
Seat Tilt Angle and Chair Height are Adjustable



## **Convenience**

Automatic Fold/Unfold, Detachable,  
Support APP Control



CE



ISO 13485



FDA



MDR





# Product Structure

## Backrest

Designed According to the ergonomics, the Pressure is Uniform and Relieves Lumbar Back Fatigue. Breathable High Elastic Mesh Fabric, Good Heat Dissipation Performance.

## Battery

International Certification, Stable Output, Safe and Reliable.

## Anti-tipping Wheel

Prevents Equipment from Tipping Over and Ensures Ride Safety.

## Rear Wheel

Natural Rubber Outer Tire, Strong Grip, Wear-resistant and Non-slipping; Inner tire with padding Design, Elastic, Puncture-Proof and Explosion-proof.

## Frame

The Innovative Exoskeleton Design, Beautiful Appearance; High-performance Aluminum Alloy Casting, Lightweight Hollow Structure, Sturdy and Durable.

## Front Wheel and Foot Rest

M4 and M4U Go with Different Front-wheel Design to Meet Different Travel Demands.

Speed Down Power Speed Up

Seat Down

Horn

Battery Level and Speed Indicator

Seat Up

Joystick

360° Joystick Control, Easy to Get Started, No Threshold For Operation.

## Legrest

Support legs for Relaxation, Three Levels Adjustable Legrest for a Comfortable Experience.

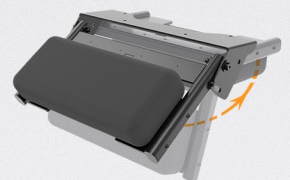

M4

## Mecanum Wheels Pedal

Self-design mecanum wheels, flexible movements in narrow space, easy to go round in circles and move horizontally.



M4U

## Universal Wheels Pedal

Wearproof and natural rubber Universal wheel, strong bearing capacity, great noise reduction, smooth movement in all rounds.





## Innovative Functions

### ■ Self-adjustable Seat Position

It adopts self-developed MengChong technology platform to realize intelligent balance and safety purpose. Based on the posture sensor + autonomous balance algorithm, it realizes automatic balance of passengers' sitting posture when going up and down the slope and crossing the obstacle, creating comfortable and safe experience.

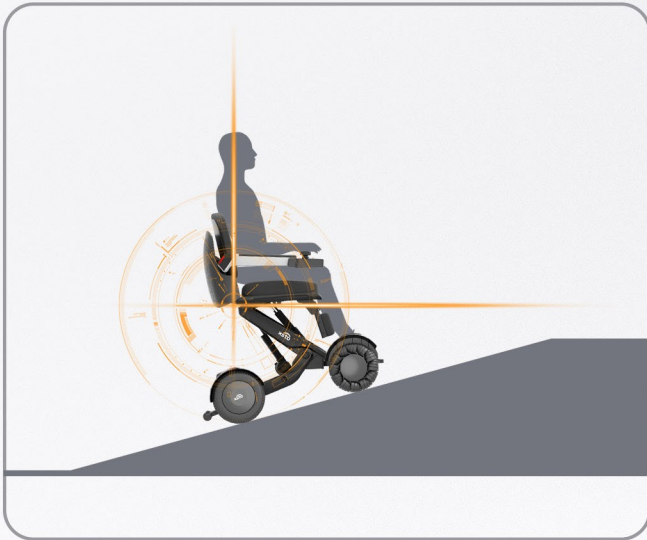

#### Uphill

When going uphill, the rear actuator automatically extends to adjust the seat gradually to be relatively parallel to the horizontal plane.

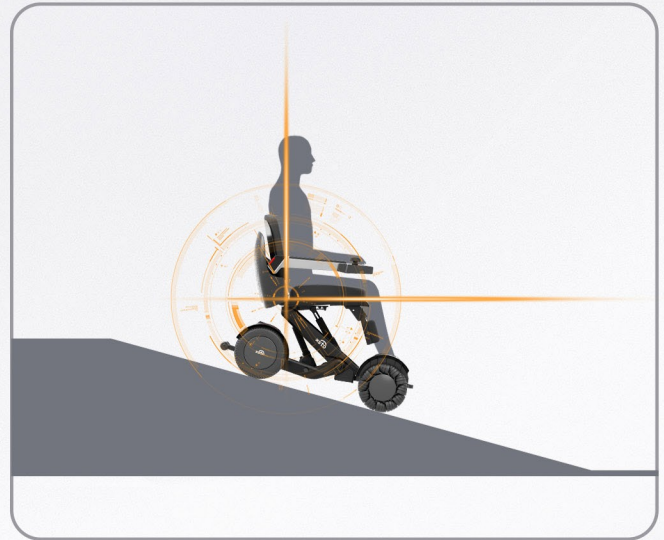

#### Downhill

When going downhill, the rear actuator automatically contracts to adjust the seat gradually to be relatively parallel to the horizontal plane.







## Innovative Functions

### Power Seat Adjustment

The overall seat can be tilted forward and backward, with a forward tilt angle of up to 16° and a rearward elevation angle of up to 25°, and the forward and backward tilt angles can be adjusted at will within the maximum range. After the angle is adjusted, the car system will automatically take the new angle as the balance posture.

25° Synchronized Rear Tilt

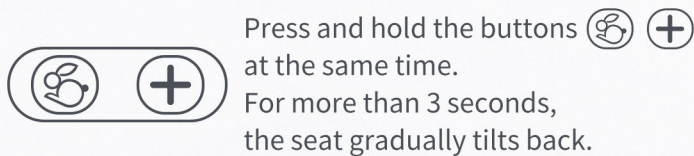

16° Synchronized Forward Tilt

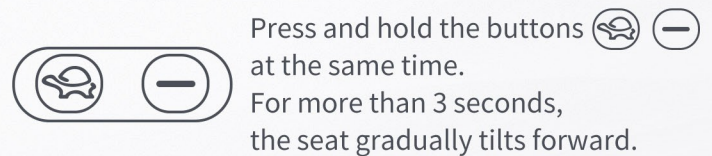

Liftable 60MM

### Height-adjustable Armrests

Lifting range of armrest is 60MM, riders can adjust according to their height, easy to operate the control handle.



# Innovative Functions

## ■ Height Adjustable

The height of M4 chair can be adjusted at will in the set range, which is easy to adapt to different heights of the desktop, and convenient for riders to work, live and socialize.



Desk



Table



Bar



Bookcase



Seat height at the touch of a button



Hold down the button “+”, the seat gradually rises, and releasing it immediately stops the seat from rising.



Hold down the button “-”, the seat is gradually lowered, and releasing it immediately stops the seat from lowering.



Note: Please adjust the M4U to the height of the “one-touch deployment” status before driving to ensure safety.





# Innovative Functions

## Modular Design

Three-step easy disassembly of the entire fuselage



1  
Loosen the quick-release wrench on the seat attachment seat.



2  
Slide the seat forward



3  
Press down on the chassis quick release area and pull out the pedal assembly

The device can be disassembled into three parts and put into the trunk of the car, easy to carry and convenient for traveling

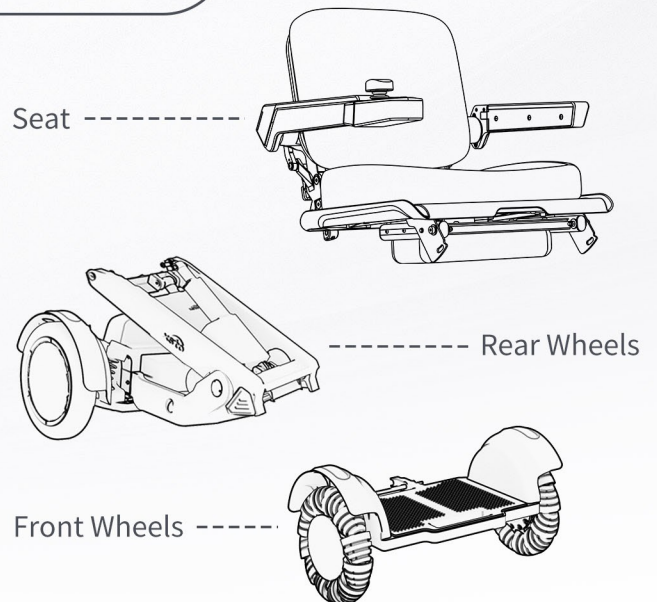

## Folding Design

The body supports one-touch folding and unfolding; the seat space has a five-link design and the backrest can be folded without taking up space for easy storage.







## Specialized Design

### High-performance Power Source

Large-capacity lithium battery and high-quality silent motor power pack, sufficient power, strong climbing and obstacle-crossing ability.



Obstacle Clearance Height

**50MM**



Pothole Clearance Width

**150MM**



Maximum Slope

**15°**

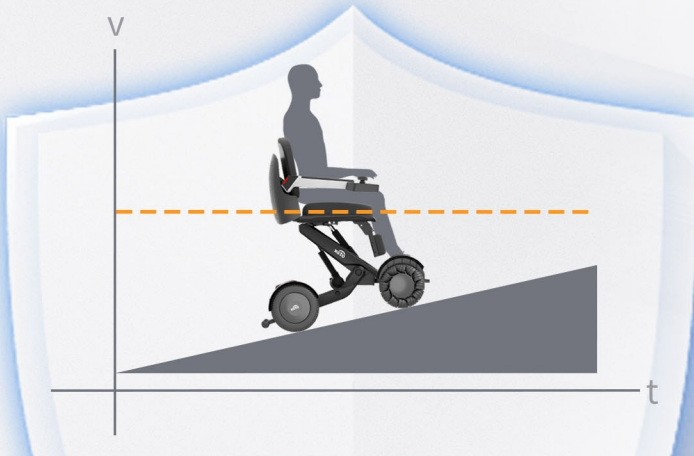
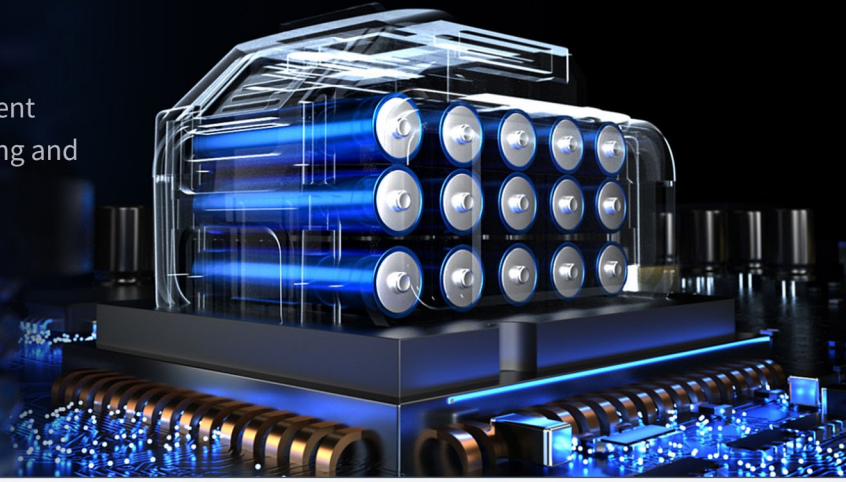

### Intelligent Drive Control Technology

Constant speed and safety throughout the operation, no rushing downhill, no slowing down uphill. It can also pass smoothly on rugged roads and slopes.

### Innovative Safety Technology System

Automatically determine the safe posture, beyond the safe value will first alarm and then lock. After the posture enters the safety zone again, the car system automatically returns to normal operation.



### Automotive-grade Four-wheel Independent Suspension

Absorbs road impacts, improves wheel ground adhesion and enhances running stability. The suspension is independent of each other, and the left and right wheels do not interfere with each other, reducing body tilting and vibration and optimizing the ride experience.







## Functions

### APP Control

Support mobile device APP online control, simple and intelligent. Remote positioning, one key summoning.



### Simple Operation

The operation interface is easy to read, and the two modes, standard and sport, can be switched at will to meet different travel needs.



### Locking Function

Equipped with smart key, convenient parking, safe and anti-theft.



Charging Port



### Removable Battery

Removable lithium battery, easy to change and carry.

### Comfortable Seat

Made of comfortable memory foam material, fit the body curve, relax the back, cushion fabric skin-friendly and breathable.

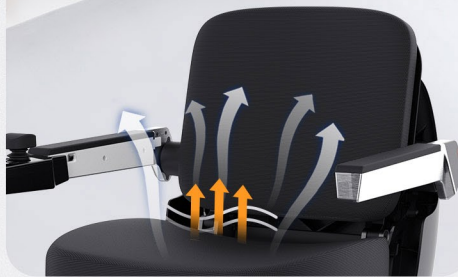

### Armrest

Adjustable armrests, easy to get on and off the wheelchair, side sitting on the car is safer.

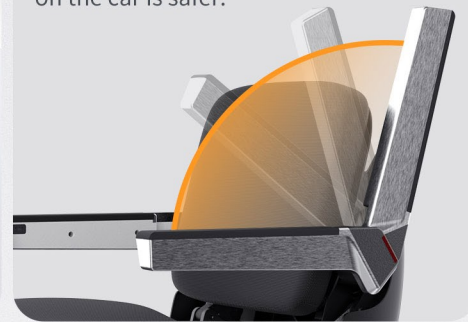

## Colors

Color Choice, Customize The M4 with 8 Different Colors



Magic Black



Superior Purple



Burgundy Red



Blue Enamel



Pearl White



Barbie Pink



Tiffany Blue



Sparkling Yellow





# Parameters

## M4 Parameters

Unit:mm



Maximum Capacity  
**115kg**



Product Weight  
**51.2kg**



Maximum Slope  
**15°**



Minimum Turning Radius  
**820mm**



Obstacle Clearance Height  
**50mm**



Pothole Clearance Width  
**150mm**



Maximum Speed  
**6km/h**



Endurance Mileage  
**17km**

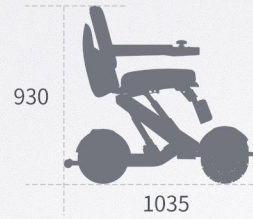

Maximum Seat Height  
**650mm**



Minimum Seat Height  
**347mm**



Lithium Battery  
**25.55V 15.6Ah**



IP Grade  
**IPX4**

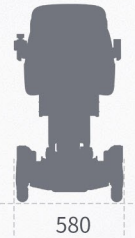
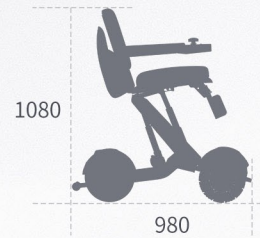

## M4U Parameters

Unit:mm



Maximum Capacity  
**115kg**



Product Weight  
**47.7kg**



Maximum Slope  
**8°**



Minimum Turning Radius  
**820mm**



Obstacle Clearance Height  
**40mm**



Pothole Clearance Width  
**150mm**



Maximum Speed  
**6km/h**



Endurance Mileage  
**17km**

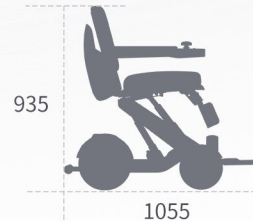

Maximum Seat Height  
**641mm**



Minimum Seat Height  
**362mm**



Lithium Battery  
**25.55V 15.6Ah**



IP Grade  
**IPX4**

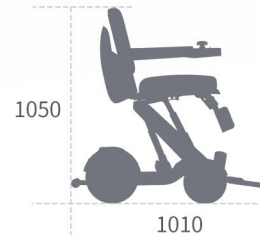





## Optional Accessories

A wide range of accessories available to enrich your traveling experience



### Raised Backrest, Neck Rest

Supports the rider's head and neck area to relieve fatigue and increase comfort



### Caravan Bag

Large storage capacity for water bottles



### Mobile Phone Holder

Fix the mobile phone, free hands, ride more freely



### Side Armrest

Extendable armrest with flashlight function to provide light source



### Umbrella Holder

Mounted on the back of the backrest to hold an umbrella

### Optional Function Cushion

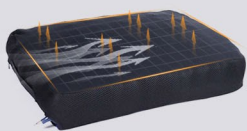

#### Inflatable Seat Cushion:

slowing down the impact, relaxing the body and reducing the pressure on the lumbar region



#### Ventilated Cushion:

Ventilated structure, comfortable and breathable, fresh and sweat-free ride





**EASE YOUR WAY  
TO ANYWHERE**

**xsto**® XSTO CO., LTD.  
Ease Your Way To Anywhere



xstomobility.com



M4 Video

+86-760-28207258   info@xstomobility.com   xstomobility.com

· 555 Plant. Ma'an Cun Rd, Cuiheng New District, Zhongshan City, Guangdong, China  
· Floor 15, No.1 Building, Beijing-Guangzhou Collaborative Innovation Center, Kaichuang Avenue, Huangpu District, Guangzhou, China