

SF-A5 CARBON POWER WHEELCHAIR

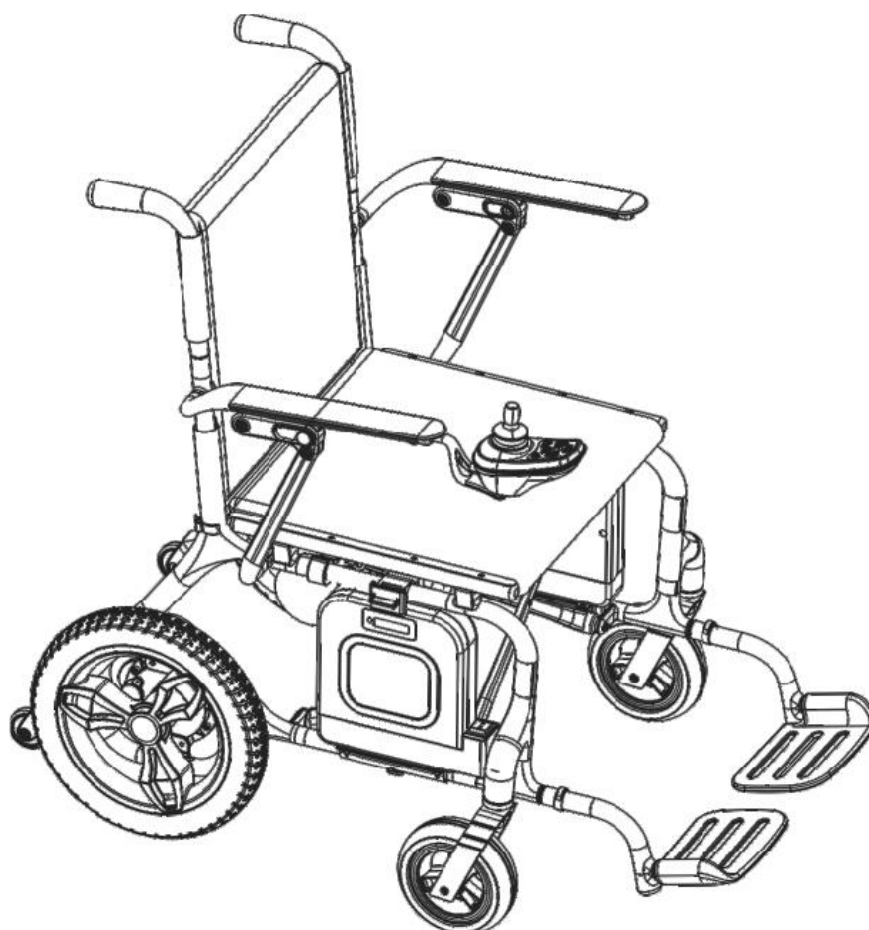





CONTENTS-----	1
1.INTRODUCTIO-----	2
2.PRECAUTIONS FOR SAFE USE-----	3
3.PERFORMANCE AND STRUCTURE-----	13
4.TECHNICAL FEATU-----	15
5.ASSEMBLING, FOLDING AND ADJUSTING-----	16
6.USE AND OPERATION-----	18
7.FAULT ANALYSIS AND TROUBLESHOOTING-----	22
8.SAFETY PROTECTION DEVICE AND ACCIDENT HANDLING-----	22
9.MAINTENENCE AND REPAIR-----	22
10.TRANSPORTATION AND STORAGE-----	25
11.GENERAL GUIDANCE-----	25

1. INTRODUCTION

Read and follow all instructions, warnings and notes in this manual before attempting to operate your power wheelchair for the first time. If there is any information in this manual which you do not understand, or if you require additional assistance for assembly or operation, please contact with your authorized local dealer. To use your product safely depends on whether you strictly follow the warnings, attentions and operating instructions in this manual. The company shall not be responsible for any injury or damage caused by non-compliance with the warnings, attentions and operating instructions.

These symbols below in this manual are used to identify warnings and important information. All of them are very important to your safety. It is strongly recommended that you should read and understand them completely.

	Warning! Failure to heed the warnings in the manual may result in personal injury.
	Attention! Failure to heed the attentions in the manual may result in damage to the wheelchair.

This product manual is applicable to the N817A power wheelchair.

1.1 This product integrates advanced technology and modern style. In particular, its quick disassembly and assembly structure is very convenient for you to store or place in the trunk of your car when you travel. We are sure that the design features, excellent performance and trouble free operation of this product will ensure your daily life is more convenient.

1.2 This power wheelchair is applicable to the disabled. The maximum loading weight is 100kg.

We reserve the right to change and update this manual without notice. The power wheelchair conforms to ISO7176 standard.

This manual will help you understand the functions of the wheelchair. In addition, operation, maintenance and repair are described. If you have any other questions, please contact your dealer or retailer.

【Intended Use】 The Electric Wheelchair is a chair equipped with wheels, it is a means of transportation for the disabled, the sick and the infirm.

【Indications】 To be used for the disabled, the sick and the old and infirm who have difficulty in moving.

【Contraindications】 Slow reaction of upper limbs, senile dementia, psychopath, physiology cannot take care of oneself person or doctor's advice request cannot user cannot use the product.

2. PRECAUTIONS FOR SAFE USE

2.1 Instructions before use

- 2.1.1. Don't operate the motorized wheelchair until you have read the instructions.
- 2.1.2. The total weight of people and things shall not exceed the maximum allowable load (see nameplate).
- 2.1.3. Don't exceed the maximum allowable gradient.
- 2.1.4. Don't go uphill or downhill at maximum speed, otherwise there is danger of rolling over.
- 2.1.5. Don't drive on very smooth or soft surfaces, such as smooth tiles, mud, sand, grass, etc.
- 2.1.6. Don't drive on slopes without guardrails.
- 2.1.7. Don't drive on the motorway.
- 2.1.8. Don't turn or drive sideways on ramps, otherwise there is danger of overturning.
- 2.1.9. Don't turn or drive laterally on the ramp, or you may roll over. Do not reverse on the ramp, or you may roll over.
- 2.1.10. Don't climb above the maximum permissible barrier height.
- 2.1.11. Don't drag the goods.
- 2.1.12. Please fasten your seat belt when using the power wheelchair.
- 2.1.13. Keep your feet and hands on the pedals and armrests at all times.
- 2.1.14. For the first time, please practice the wheelchair in the open before you can go on the road.
- 2.1.15. Please pay attention and don't be distracted when the wheelchair is driving.
- 2.1.16. Please use the crosswalk when crossing the street.
- 2.1.17. Please pay attention to the power display during wheelchair driving.
- 2.1.18. Don't cross the road when the power is low, so as not to run out of power halfway.
- 2.1.19. If the wheelchair is not used for a long time, it should be folded and stored in a dry and ventilated place.
- 2.1.20. The wheelchairs should not be stored in high temperature and humidity.

2.2 Attention in use

- 2.2.1 This power wheelchair can drive on a good flat surface; do not drive on muddy, rugged, soft, narrow, icy road, bad roads such as dangerous roads without guardrails or waterways.
- 2.2.2 This power wheelchair has the certain ability of groove obstacle, at this time you should reduce the speed and travel slowly.
- 2.2.3 This power wheelchair has the certain climbing ability, the climbing angle is $\geq 3^\circ$, but no more than 10° .
- 2.2.4 Please avoid driving in the crowds, traffic flows and other places with heavy traffic.
- 2.2.5 Please ensure that the control system is firmly installed, the joystick is vertical, correctly positioned. Please sit well and buckle up in time, keep your head as back as possible, lean against the backrest in case out of control due to the dump.
- 2.2.6 Press the on/off button, firstly check if the current fastest speed setting is appropriate for yourself operating proficiency, or it should be adjusted for

safety; We recommend to drive slowly at the beginning for each use , and gradually accelerate.

2.2.7 Indications for use: The N817A Power Wheelchair is a motor driven, indoor and outdoor transportation vehicle with the intended use to provide mobility to a disabled or elderly person limited to a seated position. This product is suitable for disabled people with mobility difficulties and elderly people.

2.4 Electromagnetic interference (EMI)

Electromagnetic interference is from external electromagnetic wave energy (like radios , TV transmission stations , CB radio waves , and garage door starters , radio phones ,etc.).Electromagnetic interference may affect the control system of the power wheelchair. Some interference may lead to the brake failure , power on automatically, or steering failure , also may lead to the permanent damages to the control systems.

Below cables information are provided for EMC reference.

Cable	Max . cable length , Shielded/unshielded		Number	Cable classification
AC Power Line	1.8m	shielded	1Set	AC Power
DC Power Line	1.2m	shielded	1Set	DC Power

Important information regarding Electro Magnetic Compatibility (EMC)

This electrical medical equipment needs special precautions regarding EMC and put into service according to the EMC information provided in the user manual; The equipment conforms to this IEC 60601- 1-2:2014 standard for both immunity and emissions. Nevertheless, special precautions need to be observed: The equipment with ESSENTIAL PERFORMANCE/Following ESSENTIAL PERFORMANCE is intended used in Home healthcare environment.

ESSENTIAL PERFORMANCE:

The power wheelchair can work normally without moving out of control, and the speed change is not more than $\pm 20\%$.

WARNING: Use of this equipment adjacent to or stacked with other equipment should be avoided because it could result in improper operation. If such use is

Necessary, this equipment and the other equipment should be observed to verify that they are operating normally” .

The use of accessories, transducers and cables other than those specified or provided by the manufacturer of this equipment could result in increased electromagnetic emissions or decreased electromagnetic immunity of this equipment and result in improper operation.

WARNING: Portable RF communications equipment (including peripherals such as antenna cables and external antennas) should be used no closer than 30 cm (12 inches) to any part of the N817A, including cables specified by the manufacturer. Otherwise, degradation of the performance of this equipment could result .”

WARNING: If the use location is near (e.g. less than 1.5 km from) AM , FM or TV broadcast antennas , before using this equipment , it should be observed

to verify that it is operating normally to assure that the equipment remains safe with regard to electromagnetic disturbances throughout the expected service life.

When the AC input voltage is interrupted, the equipment will stop battery charging and if the power supply restored, it could be recovered automatically, this degradation could be accepted because it will not lead to unacceptable risks and it will not result in the loss of basic safety or essential performance.

EMI Compliance Table (Table 1)

Table 1 - Emission

Phenomenon	Compliance	Electromagnetic environment
RF emissions	CISPR 11 Group 1, Class B	Home healthcare environment
Harmonic distortion	IEC 61000-3-2 Class A	Home healthcare environment
Voltage fluctuations and flicker	IEC 61000-3-3 Compliance	Home healthcare environment

EMS Compliance Table (Table 2-5)

Table 2 - Enclosure Port

Phenomenon	Basic EMC standard	Immunity test levels
		Home healthcare environment
Electrostatic Discharge	IEC 61000-4-2	±8kV contact ±2kV, ±4kV, ±8kV, ±15kV air
Radiated RF EM field	IEC 61000-4-3	20V/m 26MHz-2.5GHz 80% AM at 1kHz 10V/m 80MHz-2.7GHz 80% AM at 1kHz
Proximity fields from RF wireless communications equipment	IEC 61000-4-3	Refer to table 3
Rated power frequency magnetic fields	IEC 61000-4-8	30A/m 50Hz or 60Hz

Table 3 - Proximity fields from RF wireless communications equipment

Immunity test levels	
----------------------	--

Test frequency (MHz)	Band (MHz)	Home healthcare environment
385	380-390	Pulse modulation 18Hz , 27V/m
450	430-470	FM , ±5kHz deviation , 1kHz sine , 28V/m
710	704-787	Pulse modulation 217Hz , 9V/m
745		
780		
810	800-960	Pulse modulation 18Hz , 28V/m
870		
930		
1720	1700- 1990	Pulse modulation 217Hz , 28V/m
1845		
1970		
2450	2400-2570	Pulse modulation 217Hz , 28V/m
5240	5100-5800	Pulse modulation 217Hz , 9V/m
5500		
5785		

Table 4 – Input a .c . power Port

Phenomenon	Basic EMC standard	Immunity test levels
		Home healthcare environment
Electrical fast transients/burst	IEC 61000-4-4	±2kV 100kHz repetition frequency
Surges Line-to- line	IEC 61000-4-5	±0.5kV, ±1kV
Conducted disturbances induced by RF fields	IEC 61000-4-6	3V, 0.15MHz-80MHz 6V in ISM bands and amateur radio bands between 0.15MHz and 80MHz 80%AM at 1kHz
Voltage dips	IEC 61000-4- 11	0% UT; 0.5cycle At 0°, 45°, 90°, 135°, 180°, 225°, 270° and 315°
		0%UT; 1 cycle and 70% UT; 25/30 cycles Single phase: at 0°
Voltage interruptions	IEC 61000-4- 11	0% UT; 250/300 cycles UT=rated input voltage

Table 5 – Signal input/output parts Port

Phenomenon	Basic EMC standard	Immunity test levels
		Home healthcare environment



Electrostatic Discharge	IEC 61000-4-2	±8kV contact ±2kV, ±4kV, ±8kV, ±15kV air
-------------------------	---------------	---

 **WARNING!** Please observe the WARNINGS below to avoid any damage or injury resulted from improper use of your wheelchair. The wheelchair user is responsible for taking proper safety measures. We will not be liable for personal injury and/or product damage resulted from improper use of the wheelchair. Obey all local pedestrian traffic rules. It may be difficult for others to see you when you are seated on your wheelchair. Wait until your path is clear of traffic, and then proceed with extreme ATTENTION. Use of safety devices such as reflectors, reflective clothing, lights and safety symbols is very important for your safety while driving.

 **WARNING! NEVER** try a new manoeuvre on your own, out of the manual stated .

 **WARNING!** Do not use the wheelchair other than for its original purpose. Avoid any use, such as weight training sports and athletics, hauling, moving or towing anything, that may lead to safety hazards and undue stress on the wheelchair.

 **WARNING!** We strongly recommend that you do not smoke cigarettes while seated on your wheelchair. You must adhere to the following safety guidelines if you decide to do so: Keep ashtrays a safe distance from the seat cushions. Always make sure cigarettes are completely extinguished before disposal.

 **WARNING!** Before getting on/off the wheelchair, you should sit behind as far as possible to avoid injury caused by overturning.
 **WARNING!** Avoid holding on armrest, which will cause rollovers and injuries.
 **WARNING!** Avoid concentrating your weight on the footrest . Otherwise, it will cause overturning and personal injury.

 **WARNING!** Do not use the wheelchair in manual mode without accompanying person, which may cause personal injury.

 **WARNING!** When sitting in the wheelchair, please do not move by yourself, which may cause personal injury. Ask your accompanying person for help if necessary.

 **WARNING!** Do not make any alterations to the wheelchair without permission. Adding accessories may change some of the wheelchair specifications such as total weight, size, or center of gravity. Please note that some changes may damage things around you.

 **WARNING!** Please do not change your seat specification. Do not place any cushions or pillows on the seat, which will result in the user falling out from the wheelchair caused by instability of seat.

 **WARNING!** Be extremely careful when using oxygen near electrical circuits or combustible materials. Please contact your oxygen supplier for information on the safe use of oxygen.

 **Attention!** Do not change the controller Settings. Please ask your service provider to check it if you notice any changes in your ability to control the wheelchair.

 **WARNING!** During the operation, the wheelchair may suddenly stop at any time. Do not operate wheelchair if it is abnormal or irregular.

 **WARNING!** To prevent the wheelchair from losing control and moving on its own, do not place the wheelchair in manual mode on any inclined plane.

 **WARNING!** If you expect to sit in a fixed position for a long time, turn off the power to prevent movement of the wheelchair.

 **WARNING!** Avoid any accessories that may interfere with the operation of the joystick. Otherwise, it will cause the wheelchair to move unexpectedly.



WARNING! Keep yourself, clothing and other objects away from the wheel while the wheelchair is moving. Do not drag anything behind the wheelchair while driving.



Attention! Do not connect any other devices to the electronic system or turn on any other devices with the wheelchair battery.



Attention! When disconnecting wiring harness, please hold the terminal in case damage to it. Do not pull the wiring harness directly.



WARNING! Keep all charger connector terminals clean and dry, away from damp sources to prevent damage to electrical system and personal injury.



Attention! The storage temperature of wheelchair is 0°C~50°C. Long term storage in low or high temperature environment will damage its function.



Attention! Always check electrical components for Corrosion. Check all brakes for looseness, wear or Damage. Check wiring harnesses and terminal posts for breakage. If necessary, please do the replacement.



Attention! Please ensure the safety of wheelchairs and batteries during transportation. Never transport wheelchairs or batteries with combustible materials.



Attention! Do not connect the cable directly to the battery terminal/clip for charging.



Attention! Do not remove the fuse from the battery harness. If the fuse is damaged, please contact your supplier for replacement.

WARNING! Do not operate the wheelchair with dead battery. You might get trapped.

WARNING! Please slow down when turning, don't make sharp turns, keep the center of gravity stable when turning. To prevent rollover, do not move the center of gravity in the opposite direction when turning.



WARNING! Drive straight up the slope when climbing .

Both front wheels should land at the same time .To reduce the possibility of overturning,do not make an angle with the slope;do not make the wheel on one side or the side of the wheelchair to go up the slope first. Be particularly careful when climbing any slopes.

WARNING! Do not drive on potentially dangerous roads or slopes, including but not limited to roads covered with snow,ice , cut grass,or wet leaves .



WARNING! Please drive down a slope at the minimum speed. If the descent speed is faster than expected, release the joystick lever to stop the wheelchair, and then press the lever lightly to control the descent speed.



WARNING! Do not place the wheelchair in the front seat of vehicle during transportation .Otherwise,it may move and disturb the driver.



Attention! Please contact your service provider if any accessories of seat unit become loose; Please replace the worn or damaged parts immediately.

WARNING! The recommended maximum climbing angle (see parameter table) was tested in a controlled environment. The climbing ability of your wheelchair is affected by factors such as your weigh, the speed of your wheelchair, and the angle at which you approach the slope.



WARNING! Reversing is only possible on flat roads. When reversing,please operate smoothly at low speed. Please stop frequently and check to make sure there are no obstacies on the road.To prevent rollover,do not tilt down or backward along the slope.





WARNING! When sitting in a wheelchair, avoid any position or movement that can change your center of gravity. This may cause the wheelchair to tilt.

WARNING! Do not put all the weight on one side of the wheelchair armrest, such use may cause the wheelchair to tilt.



WARNING! Do not put your hands above the seat or tilt your body. This may damage the backrest and cause you to fall down.



WARNING! Even if your wheelchair can cross high obstacles, we recommend that you do not try to cross the specified height. Such operations may cause the wheelchair to be unstable, even rollover and cause severe personal injury. If you have any concerns about safely crossing obstacles, please ask for help. Please pay attention to your operating skills and personal restrictions. You may need to remove or cover the sills and install ramps at exits and entrances.



WARNING! Do not attempt to climb over obstacles on.

WARNING! Do not rely on a wheel to get over obstacles.



WARNING! Never operate the wheelchair near railroad tracks or crossings.



WARNING! Do not drive the wheelchair along the edge of a stream, lake or sea.
Please do not drive the wheelchair across the water.



WARNING! Do not expose wheelchair to open flames.



ATTENTION! Keep your wheelchair in a dry and clean environment. Don't take the wheelchair to shower, bath, pool or sauna. Rain, snow, salt, fog / spray conditions and frozen / smooth surfaces can cause wheelchair screws and some fixtures to rust untimely.



ATTENTION! Avoid prolonged exposure to excessively hot and cold environments; it may damage the cushioned and non-cushioned parts of the wheelchair as well as the battery and battery components.



ATTENTION! Do not drag the wheelchair. Dragging may exceed its own speed threshold ,causing damage to key parts of the wheelchair.



ATTENTION! Be extremely careful when moving an idle wheelchair up and down the stairs .The wheelchair must be folded , requiring the participation of physically capable people.



WARNING! Do not cross stairs or escalators with the wheelchair.



WARNING! Do not sit on a wheelchair while it is in any transport vehicles.



WARNING! For safer handling: Always keep the power off before moving . Failure to do so may result in touching the joystick and causing the wheelchair to move unexpectedly. Make sure the brakes are locked so to prevent the wheelchair from moving during handling . This wheelchair could be driven into the elevator, while you must turn off the power and sit firmly to ensure that the wheelchair will not move after entering the elevator.



WARNING! Do not operate your wheelchair while you are under the influence of alcohol , as this can impair your ability to safely operate your wheelchair.

WARNING! Every wheelchair is different.Take the time to learn it before your driving.

WARNING! BE AWARE that becoming a capable and safe wheelchair operator will take time and practice.

WARNING! Radio wave sources , such as radio stations , television stations , amateur radio transmissions , two-way radios and mobile phones can affect wheelchair control .

The following WARNINGS should reduce the possibility of severe injury due to accidental braking or movement of the power wheelchair:

- 
- 1.Do not turn on portable personal communication devices , such as citizen band (CB) radios and mobile phones when the power wheelchair is powered on;
 - 2.Pay attention to nearby transmitters , such as radio or television stations , and try to avoid approaching them .
 - 3.In the event of unexpected movement or brake release , the power wheelchair should be turned off as soon as possible under safe conditions;
 - 4.Please note that adding accessories or parts,or modifying power wheelchairs may make it more susceptible to interference from radio wave sources (note: there is no easy way to assess the influences of above modifications on the wheelchair's overall immunity from radio wave sources); and report to the power wheelchair manufacturer of all accidents of unexpected movement or brake release , and pay attention to nearby radio sources and other important information.



Attention! Please return the discarded batteries, controllers ,motors ,etc. to the supplier or manufacturer for disposal to avoid environmental pollution.



WARNING! To ensure your safety, please read and understand this manual . You must be on high alertness when driving any wheelchair to ensure safety.



WARNING! Please consult your healthcare professionals routinely to ensure there are no health or physical conditions that may limit or impair your ability to safely operate your wheelchair. Consult your physician if you are taking prescription or over-the-counter medication or if you have any physical limitations. Some medications and physical limitations may impair your ability to safely operate your wheelchair.

3.PERFORMANCE AND STRUCTURE

3.1Product Structure

The Power wheelchair is mainly composed of front wheel, drive wheel, frame, controller, motor and drive devices, armrest, push-handle, backrest, seat cushion, footrest, battery box and charger. The structural diagram is as below

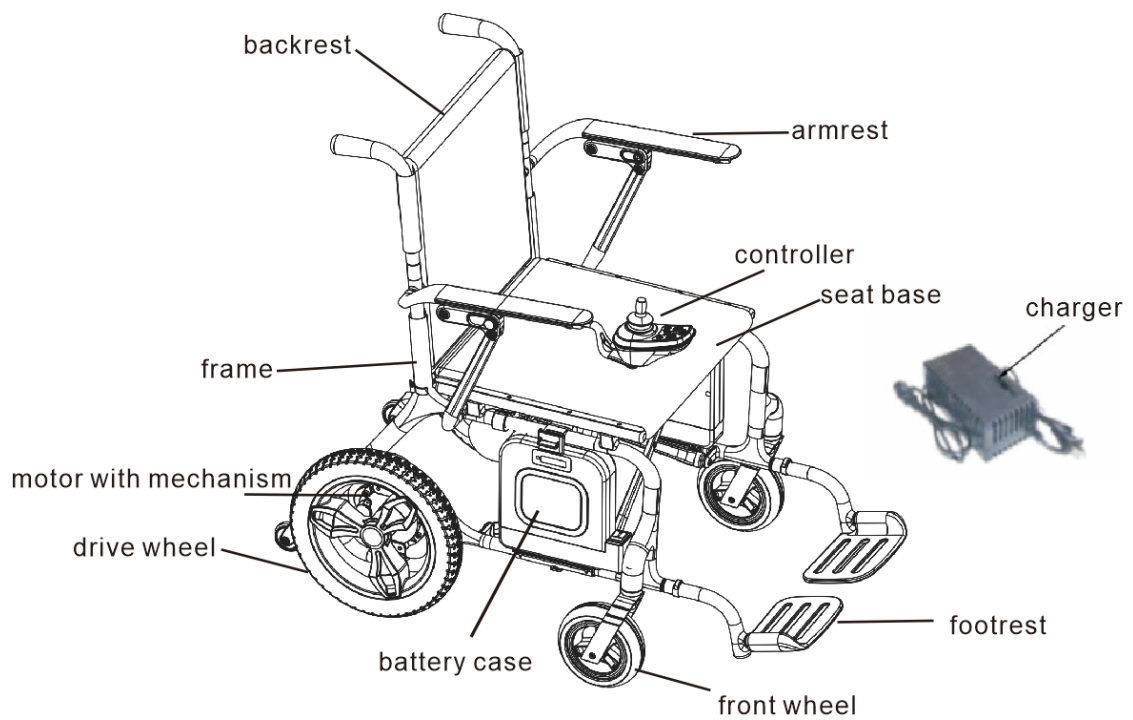

3.2 Product characteristics of the power wheelchair

- Classification by anti-shock type: wheelchair is internal power supply;
- Classification according to the degree of anti-shock: wheelchair belongs to the B-type application part;
- Classification according to the degree of protection of the feed: IPX0;
- Safety degree when used in flammable anesthesia mixed with air or flammable narcotic with oxygen or oxidized nitrogen Category: Non-AP or APG equipment;
- By operating mode: continuous operation;
- Wheelchair rated voltage and frequency: DC 24V;
- Input power of wheelchair: internal power supply equipment; Whether the wheelchair has a protective effect on defibrillation effect: No;
- Whether the wheelchair has a signal output and input part: No;
- Permanent installation of equipment or non-permanent installation of equipment: mobile devices.

3.3 Electric diagram of power wheelchair

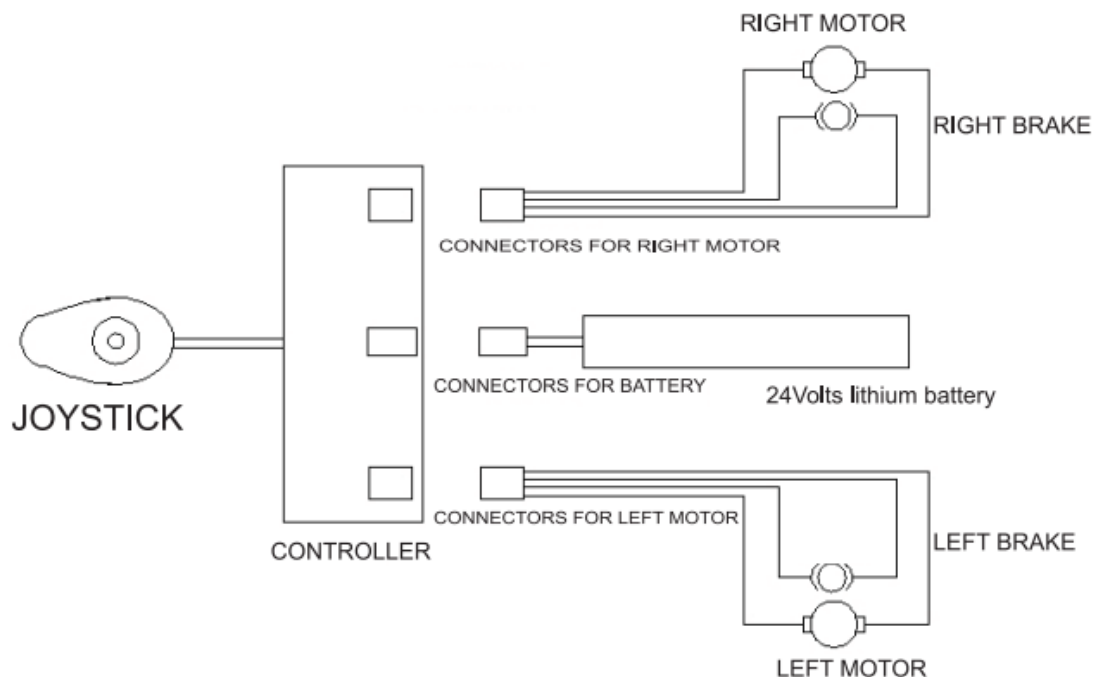

4. TECHNICAL FEATU

The main Performance Parameter of Power Wheelchair

Overall dimensions(L*W*H)	960*630*865mm
Folded dimensions(L*W*H)	745*365*865mm
Net Weight	12.2kg (without battery)
Planar Angle	3.5°
Effective Seat Depth	400mm
Seat Width	400mm
Effective Seat Width	530mm
Front Seat Surface Height	480mm
Backrest Angle	8.5°
Back Height	392mm
Back Width	425mm
Armrest Height	235mm
Armrest Front Position	350mm
Armrest Length	275mm
Armrest Width	50mm
Maximum Over the Obstacle Height	≥25mm
Maximum Speed	4.5km/h
Braking Distance on Horizontal Road	≤1000mm
Minimum Turning Radius	≤900mm
Maximum Load Capacity	100kg
Driving Distance	≥10km
Climbing Ability	≥6°
Maximum Climbing Degree	≥3°
Static Stability	6°
Dynamic Stability	≥3°
Motor Model	24V/150W*2
Lithium Battery Specification	10Ah(N817); 20Ah(N817A)
Maximum Output Current of Controller	50A
Maximum Output Current of Charger	2A
Front Wheel Specification	outside size of 150mm
Rear Wheel Specification	outside size of 300mm

Note:

- 1)The weight capacity is tested with a dummy or personnel of same weight.
- 2)Maximum Potential Range is tested on flat road with average speed,it will vary due to drive surface, operation habit, etc.

5. Assembling , Folding and Adjusting

5.1 Assembling

5.1.1. Put the wheel chair off the ground, pull the left and right frames apart, and push down the seat.



5.1.2. Insert the backrest tube into the frame and snap the pin into place.





5.1.3. Attach the pedal assembly to the frame, align it with the hole, and snap the latch in.



5.1.4 Push up the battery latch switch and then rotate the battery to remove the battery easily.

2 batteries: 1 means power on the right; 11 means power on the left; 0 indicates no power supply.

1 battery: 1 means power on the right; 0 indicates no power supply.



6.USE AND OPERATION

6.1Use

6.1.1All the electric components to control the wheelchair are integrated to the joystick, including ON/OFF switch; speed light; battery gauge; speed light; speed down button; speed up button ;joystick. You can implement all the operations of this wheelchair the above buttons.

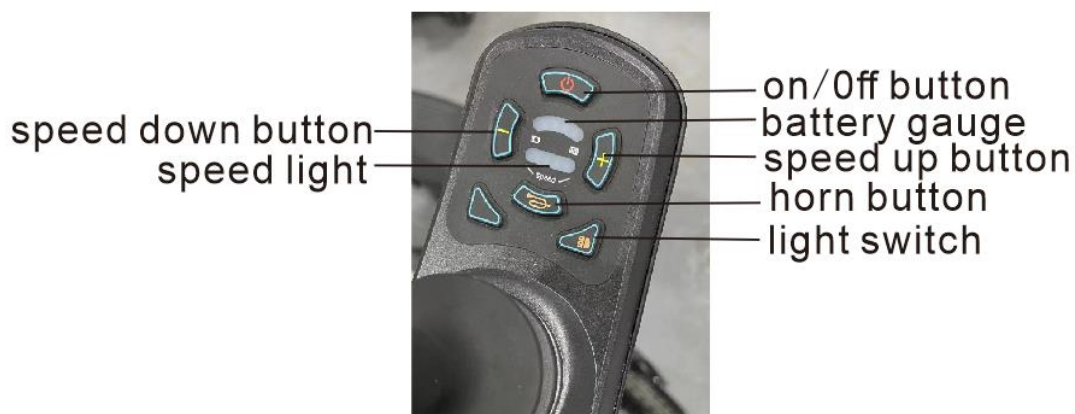

6.1.2 ON/OFF switch : It is the switch to supply power to the control system. Press the ON/OFF switch to turn the power on.the power indicator speed light and battery gauge will be on. Press it again, the power is off, then speed light as well as the battery gauge will go out.

6.1.3Speed down button: After turning on the power, the speed light displays the current maximum driving speed, and will decrease by one bar with each press on it. The number of displayed bars represents the current maximum speed. The range could be adjusted by the user.

6.1.4 Speed up button: After turning on the power, speed light displays the current minimum driving speed,and will increase by one bar with each press on it. The number of displayed bars represents the current maximum speed. The range could be adjusted by the user.

6.1.5 battery gauge: It displays the battery storage. All bars lit : power is sufficient; 3-4 bars displayed indicates the power is ok. Lower than 2 bars indicates lack of power and the battery needs to be charged.

6.1.6 Joystick: The joystick is mainly used to control the wheelchair's movement including its speed and direction(forward, backward and left or right etc). The further you push the joystick from its central position, the faster the wheelchair moves. Whenever you release the joystick, it will automatically go back to the center and the brake will be automatically operative to stop the wheelchair.

6.1.7 Reserving sound can be closed by pressing the buttons of speed-down and horn simultaneously for 3 seconds. If need to turn it on, please press the

buttons of speed-up and horn for 3 seconds at the same time, and then the sound will be on.

6.1.8 Charger Socket: It is only used to this wheelchair. Do not use the socket to supply power to any other electrical equipment. Otherwise, it may damage the wheelchair's control system or its E.M.C performance(Electromagnetic tolerance).

 **WARNING!** Avoid any accessories that may intervene the operation of joystick. Otherwise, the wheelchair may move accidentally.

 **WARNING!** If your wheelchair moves accidentally, please immediately release the joystick and the chair will stop automatically.

 **CAUTION!** If you connect any devices other than the supplied battery charger into the socket, causing damage to the control system, then the warranty is invalid.

6.2 Batteries and Its Usage

6.2.1 Fully charge your new battery prior to its initial use. This brings the battery up to about 90% of its peak performance level; Give the battery another full charge of 4-6 hours and operate your wheelchair again, the batteries will now perform at over 90% of their potential; After four or five charging cycles, the batteries will top off at 100% charge and last for an extended period. Please replace a new battery when the battery failure, and the old battery must be returned to supplier because of environmental pollution.

 **CAUTION!** Do not use your wheelchair when the temperature is less than -25 °C or above 50°C.

6.2.2 Charging batteries

The battery charger is an important part of the wheelchair. The off-board charger attached to this product can charge its batteries quickly and easily to make your wheelchair the best.

 **CAUTION!** Do not use your wheelchair when the temperature is less than -25 °C or above 50°C.

6.2.3 Battery Removal

The battery can be removed from the wheelchair and recharged.



6.2.4 Safety Belt

For your safety on the way, you have to fasten the safety belt whenever you seat on the wheelchair.

Snap the belt buckle so to hear a click (fig.17)



 **WARNING!** Please do not operate the wheelchair while charging.

 **ATTENTION!** Please do not mix up the new and used batteries.
ATTENTION! Please replace with battery of same type, chemical substances and capacity. Please select the battery type and capacity per specification in the manual. Please use the replacement battery directly provided by the authorized supplier(s) to ensure the performance and function.

 **ATTENTION!** Please protect the battery from freezing; Please do not charge the frozen battery, otherwise the battery may be damaged.

6.3 Battery replacement

If the battery needs to be replaced, release the battery pack buckle underneath the seat then take it out.

6.4 Operation

6.4.1 Preparation before operation

- Do not turn on the power switch when sit on the power wheelchair, and do turn off the power switch when get off from the wheelchair. Please observe whether the hand brake works or not.
- Please fold the pedal first then hold the armrest to sit on the wheelchair; Do not get off the wheelchair by stepping on the pedal. Otherwise the chair maybe turned over, which is dangerous.

6.4.2 Practice before operation

- Find a spacious place like square and have a assistant to help you practice until you have enough confidence to operate it.
- Be certain to shut down the power when you up and down the wheelchair, and set a speed you need through speed adjustment button.
- We recommend you set the lowest speed until you can operate the electric wheelchair skillfully.
- To Practice the stop operation, forward and backward. Push the handle, the wheelchair move to anywhere you want.

● Firstly, ensure that it is the lowest speed when practice forward operation. After Skilled, you can practice "S" shaped turn. After you are familiar with "S" shaped turn, to practice backward operation, and pay attention to the speed control setting. And the backward speed should lower than forward speed. (As shown below)

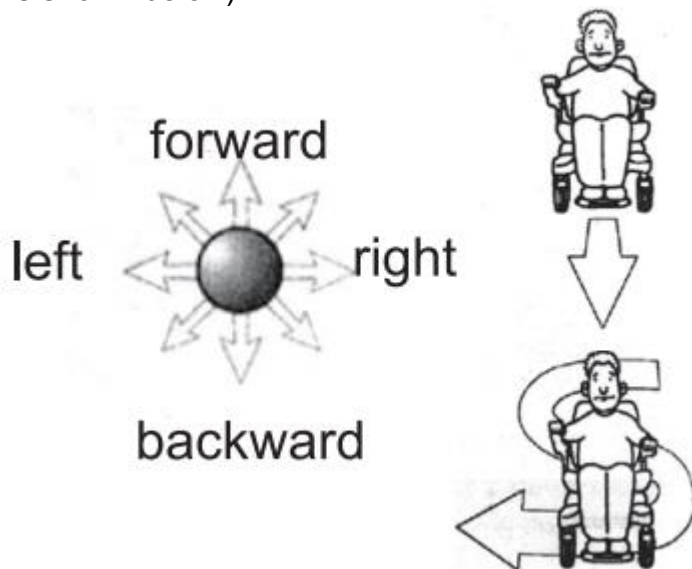

WARNING! Do not press the joystick hard by hand when getting on/off the wheelchair to avoid any accident(Fig.18)



fig.18



WARNING! Do not use your wheelchair unless getting help from your assistant when the wheelchair is in manual mode. Otherwise it may result in personal injury.

Do not set your wheelchair in manual mode by yourself while you are seated in the wheelchair. Otherwise it may result in personal injury. In this case, please ask your assistant to help you.

Do not set your wheelchair in manual mode when it is on an incline. Otherwise, the wheelchair could be out of control to roll down by itself, and result in personal injury.



7. FAULT ANALYSIS AND TROUBLESHOOTING

For your convenience, this wheelchair is equipped with an automatic fault warning device . Once it is out of order, the controller panel will display the pattern and the horn will sound . You can find where the fault is according to the table below. If the fault persists after checking , please contact your service agent.

Beep 2+1	Communication failure	Check connection inside the joystick
Beep 2+2	Right motor failure	Check right motor or wire connection
Beep 2+3	Right brake error or cable connection poor	Check if the brake lever is in place & if the brake is damaged
Beep 2+4	Left motor failure	Check left motor or wire connection
Beep 2+5	Left brake error or cable connection poor	Check if the brake lever is in place & if the brake is damaged
Beep 2+6	Overcurrent	Check if the motor is locked or short circuit or if the joystick is damaged
Beep 2+7	Joystick lever failure	Check if the joystick lever works normally or the inside connection is loose
Beep 2+8	Joystick failure	Check with supplier for repair
Beep 2+9	Battery failure	Charge the battery, if still not work, replace a new battery with same specification

ATTENTION!

⊗ In order to ensure the quality of wheelchair, during the maintenance, if any consumable parts such as battery, wheels, joystick, motor/actuator and charger need to be replaced, please contact this company or dealer, replacing the original parts of same model and specification.

8. SAFETY PROTECTION DEVICE AND ACCIDENT HANDLING

8.1 Overload protector: Refer to instruction manual 6.1.7

8.2 Safety belt: Refer to instruction manual 6.1.9

8.3 Please release the joystick whenever there is a wheelchair fault , the wheelchair will be stopped.

9. MAINTENANCE AND REPAIR

9.1 Maintenance

Like other motorized vehicle , your power wheelchair also requires routine maintenance . Some checks can be performed by yourself, others you can ask for assistance from your service agent . Preventive maintenance is very important . If you follow the maintenance and checks in this section , your wheelchair will give you years of trouble-free operation . For any questions

regarding the maintenance or operation of the wheelchair, please contact your dealer or our after-sales service dept .

9.1.1 Humidity

Your wheelchair, like most electrical and mechanical equipment , is susceptible to external conditions . In any case , the wheelchair should be avoided damp environment . Direct or prolonged exposure to water or dampness could cause the wheelchair to malfunction electronically and mechanically. Water can cause electrical components to corrode.

9.1.2 Temperature

- Some parts of your wheelchair are susceptible to temperature.
- Some parts of your wheelchair are susceptible to temperature.
- In extremely cold temperature, the battery may be frozen. Special temperatures may cause a lot of factors to freeze, like charger type, usage, battery components (such as sealed lead-acid batteries or gel batteries);
- Temperature above 55° may cause your wheelchair's speed to reduce.

9.1.3 Regular guidance

- Avoid beating the controller, especially the joystick.
- Avoid prolonged exposure of your wheelchair to extreme conditions, such as hot, cold or moisture environment.
- Keep the controller clean.
- Check all electric connections, including the cable and connectors of the charger, and ensure that they are all tight and secure.
- If only red LEDs on the Battery Gauge lights, the batteries are nearly running out of charge. You should recharge the batteries as soon as possible. We recommend charging the battery for 8-12 hours
- Check the rear wheel inflatable situation, if the tire deformed serious when riding, it should be inflated;
- The frame surface has been sprayed with a clear sealant coating. You can apply a light coat of car wax to make the surface keep a high gloss.
- Check all cable connections. Make ensure they are fastened and are not corroded. The battery must be placed in the battery area, flat, the battery plug inward, relative display, refer to the correct connection on the main frame label;
- All wheel bearings are lubricated and sealed. Do not need to lubricate them.
- Check if there is loose phenomenon for wheel hub, drive device, and chair itself, if loose, please screw tightly in time.

9.1.4 Maintenance after use

- Turn off the power.
- Inhibit children and unconscious persons to use the wheelchair.
- Store the wheelchair in normal temperature to prevent deformation so that it keeps its performance for long period .
- Clean the wheelchair with a clear and soft cloth and dry it . Never use any chemicals to clean it . (to prevent deformation and discoloration) .
- Remove the cloth cover of the seat rest to be washed if it is dirty, and then dry it for use .

9.1.5 Daily Checks

In order to keep the wheelchair always in good condition , you should check it before each use and keep weekly, monthly, semi-annual check . See the table below for the inspection items.

Inspection Items	At any time	Weekly	Monthly	Semi-annual
Each part			⊙	
Turning, driving, setting, dismantlement, etc		⊙		
brake	⊙			
Connecting lines		⊙		
Battery condition	⊙			
Tire Condition			⊙	
Motor				⊙
Devices		⊙		
Cleanliness	⊙			

9.1.6 Cleaning

Way of cleaning as below:

- Clean the frame, motor, controller and joystick with a cloth coated with diluted detergent. When cleaning the joystick, be careful not to use excessive force. Do not use abrasive or alcohol-based cleaners.
- After the use of the wheelchair for a month, the seat cushion and back should be wiped and checked for damp or mildew, if any, should be put in the sun to dry.

9.2 Repair

9.2.1 Users could repair or replace some spare parts like push handle, push handle cover which could be self-maintained or replaced under the instructions of after-sales service staff of our corporation or the dealers'.

9.2.2 Within the warranty, our corporation or the dealers will maintain or replace the faulted spare parts, like motor, battery, charger, controller, bearing, shaft sleeve, etc., due to material or manufacturing defects free of charge.

9.2.3 The spare parts like motor, controller, etc. which are confirmed by the after-sale staff or our corporation or our dealers' to be disassembled could be sent to our corporation or the dealers for maintenance.

9.2.4 Please contact your distributor or the after-sale service dept of our corporation for any questions regarding the maintenance of power wheelchairs.

ATTENTION!

In order to ensure the quality of wheelchair, during the maintenance, if any consumable parts such as battery, wheels, joystick, motor/actuator and charger need to be replaced, please contact this company or dealer, replacing the



original parts of same model and specification. The repair should be carried out at the professional maintenance room of our corporation or the dealer(s) .

10. TRANSPORTATION AND STORAGE

10.1 Transportation

You can load and transport according to the shipping marks and graphics on cartons. For details, see the attachment .

10.2 Storage

After packaging, the wheelchair should be stored in a room with temperature of $-10^{\circ}\text{C} \sim +50^{\circ}\text{C}$, relative humidity of no more than 90%, atmospheric pressure of 560 ~ 1060hPa, no harmful gas enough to cause corrosion and good ventilation, and no piling under heavy pressure.

【Package】 Carefully packaged in a cardboard box.

【Shelf Life】 60 months

11. GENERAL GUIDANCE

11.1 Avoid knocking or hitting the control units;

11.2 Avoid prolonged exposure of your wheelchair to extreme conditions, such as hot, cold or moist environment; keep the controller clean.

11.3 Check all connections, and ensure that they are all tight and secure.

11.4 Check all cable connections, including the cable connection of the charger. Make sure they are firmly fastened and not corroded. The battery pack must be correctly installed into the slide rail.

11.5 After each use, the power switch should be turned off in time to reduce unnecessary consumption of the battery.

11.6 The wheelchair has power-saving function. If no operation to the wheelchair within 20 minutes, the controller would cut off the power automatically. If need to continue operating this wheelchair, please turn it on again.

11.7 All wheel bearings are lubricated and sealed. No need to lubricate them.